

CONFERENCE
TABLES
**EXCLUSIVE PRAKTIK
ROL ROS**

thulema

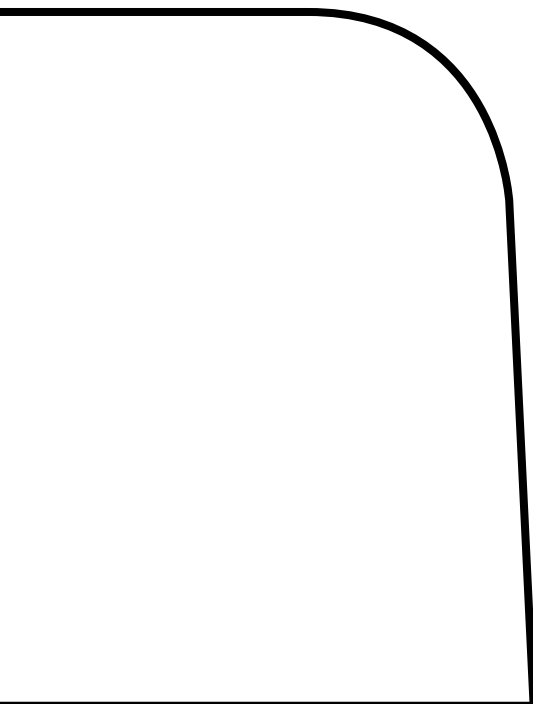

THULEMA

Thulema creates 21st century furniture for 21st century offices and public spaces. We follow and pay forward the high level of quality we have set for ourselves both when working with our clients and when making assembling and installing our furniture.

Sometimes, we all need to gather around a big table to talk things through, to negotiate, agree, review or sign something.

In order to move on, it's worth stopping for a minute and looking back, listening, and noticing others around you. And only then make a decision. A table probably doesn't help you make these decisions, but it certainly adds some weight to them.

Enjoy your meeting!

Martin Pärn,
designer
iseasi

A handwritten signature in black ink, consisting of stylized, overlapping letters that appear to read 'MPARN'.







EXCLUSIVE

The respectably refined yet light look of the Exclusive table has been created by combining a massive veneered desktop, solid wood legs and a stainless steel frame.

These tables have 1200 mm wide desktops and they come in two lengths, 2400 and 3000 mm, seating 6-8 or 8-10 people, accordingly. The sockets required for equipment will be integrated into the desktop according to your needs. And for that elegant finish you really want, you can choose from a hand-refined patina oak, blackish-brown stained oak called coffee or from a natural light maple veneer.

06

PRAKTIK

This is a practical and unpretentious table that is perfect for meetings or teamwork sessions for up to 10 people. The selection includes melamine desktops and grey or white steel frames.





ROS

Ros is a soft-shaped conference table that rests on central legs. It is suitable for meetings of up to seven people, but you can also create a single curved workspace by putting Ros tables next to each other in bigger meeting rooms.

08

ROL

The Rol tables have been created specifically for seminar and training rooms. These tables are perfect for learning and can be used for creating table rows and islands when one needs to listen to presentations or present project-based teamwork. These tables also come with castors, making them exceptionally convenient in multifunctional rooms.

The smallest desks for a single person are well-suited for training rooms. If necessary, the light Rol tables can easily be stored in stacks of five. The tables come with melamine boards or with 10 mm compact boards.



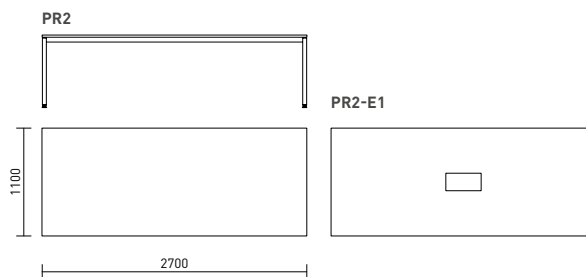
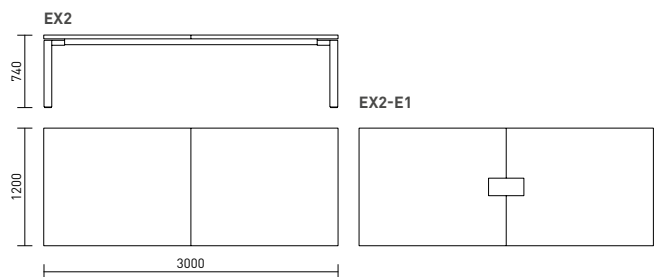
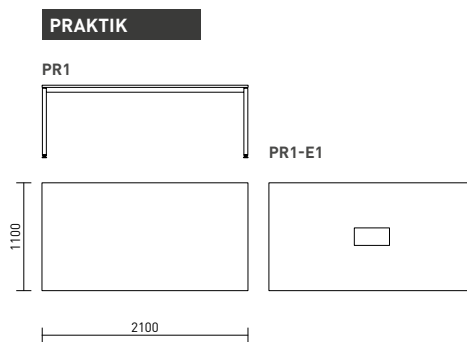
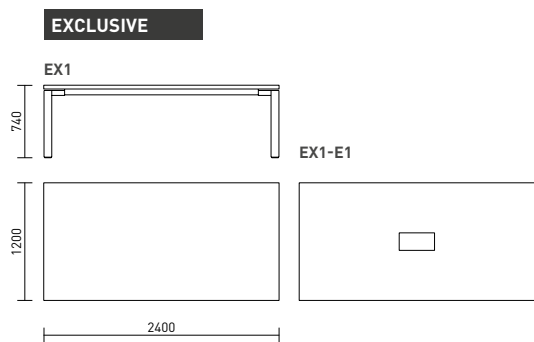
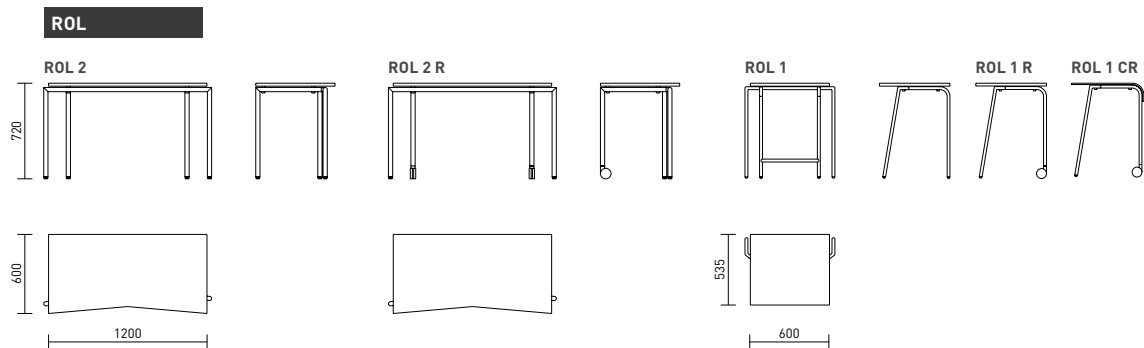

All conference tables are available with a set of sockets integrated into the tabletop. The sockets included in the standard selection are 3x220 V + 2 DATA + 1 VGA.

10

ROS

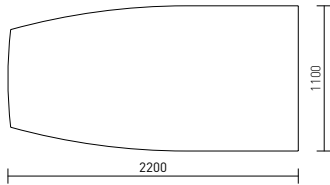

ROS-E1

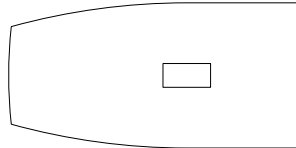

	FINISH	EXCLUSIVE	ROS	PRAKTIK	ROL
VENEER	OAK PATINA		*	*	*
	OAK COFFEE			*	*
	OAK WHITE			*	*
	MAPLE			*	*
	MAPLE COGNAC	*		*	*
	MAPLE WHISKEY	*		*	*
MELAMINE	BIRCH	*			
	WALNUT	*			
	WHITE	*	*		
	BASALT GREY	*	*		
	STEEL GREY	*	*		
	OLIVE GREEN	*	*		
	WHITE COMPACT BOARD	*	*	*	

METAL LEGS	WHITE	*	*		
	LIGHT GREY	*	*	*	
	DARK GREY	*			*

KITMAN THULEMA AS

Kesk-Sõjamäe 3

11415 Tallinn, Estonia

